



hd PL16

PowerLine Stick

The **hd PL16** is a passive 1-way column speaker with an elegant look and excellent sound characteristics. The sixteen high-performance 3" fullrange chassis produce a coherent sound field with a cylindrical wave propagation. The true cylindrical wavefront provides better speech intelligibility compared to other column loudspeakers and predestines the hd PL16 PowerLine Stick for use in difficult acoustic environments such as churches, train stations, airports or concert halls where clarity, performance and an unobtrusive look is required. The large range of up to 25 m and horizontal coverage of 80° ensures efficient sound solutions with only a few speakers. The shielded 3" chassis produce a punchy sound with simultaneous hi-fi resolution. The M6 square nut through-hole on the back of the speaker allows all mounts or a tilting tripod adapter to be attached. A Speakon jack is located on the bottom plate for connecting inputs in mobile applications. The tripod adapter with mounting adapter is recommended for mobile applications.

Features

- real cylindrical wave propagation
- elegant design
- precise, even sound emission
- coverage pattern 80° x 10°
- excellent speech intelligibility
- discreet room integration
- 100V version available
- custom length possible

Anwendung

Restaurants, bars, airports, train stations, home theater, conference rooms, hotels, A/V installations, multimedia applications, meeting rooms, TV studios, churches, live music, DJ, concert halls, radio

Model	hd PL16
Order number	60220
Acoustic design	LineSource
Transducers	16x 3" fullrange chassis
Impedance	4 Ω
Coverage (hor x ver)	80° x 10°
Frequency range (-6dB)	130 Hz - 18 kHz
Sensitivity (1W / 1m)	96 dB
Power Rating AES / Peak	600 / 840 W
SPLmax @ 10% THD	127 dB
Enclosure	powder-coated aluminum profile black, steel grille with acoustic foam, 1x Speakon NL4 on the bottom cover
Optional Accessories	Tripod adapter 19780 (Art. 900856) Transport bag (Art. 30108) Double case (Art. 950046) RAL color, Special length Weather resistant, 100V-Transformer
Weight	11 kg
Dimensions (W x H x D)	108 x 1353 x 104 mm

hd PL16 datasheet

Dimensions [mm]

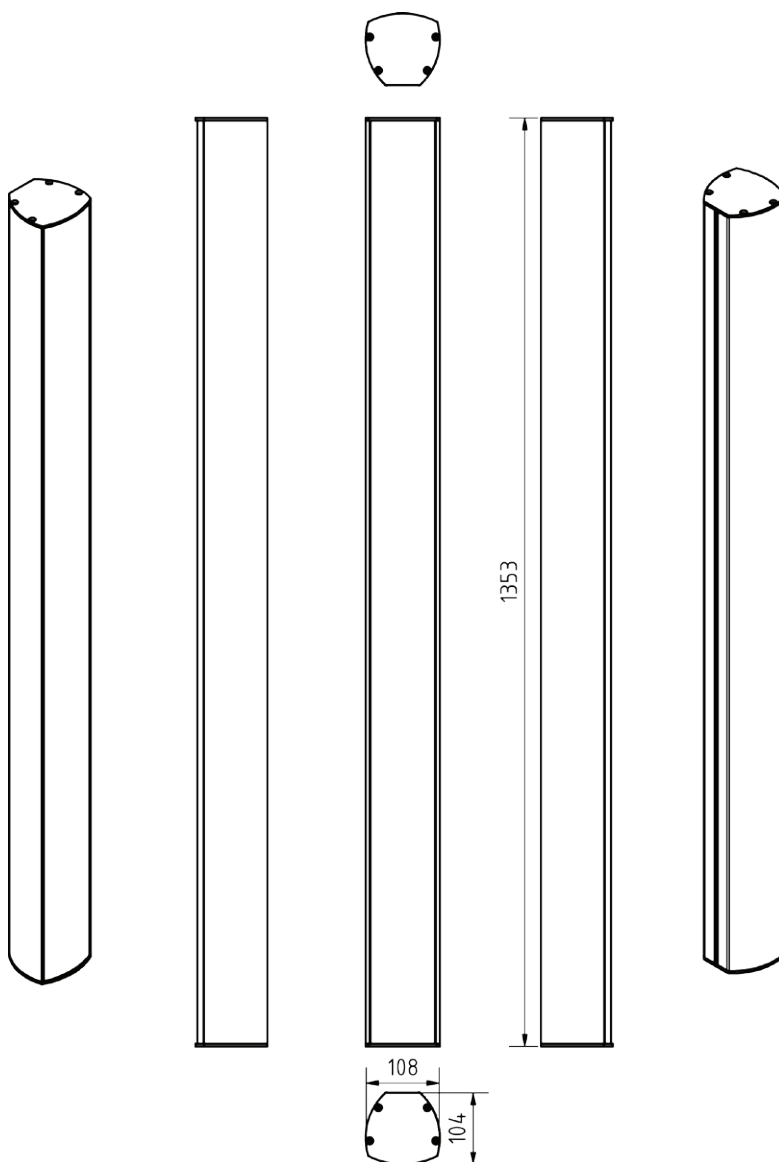

Impedance

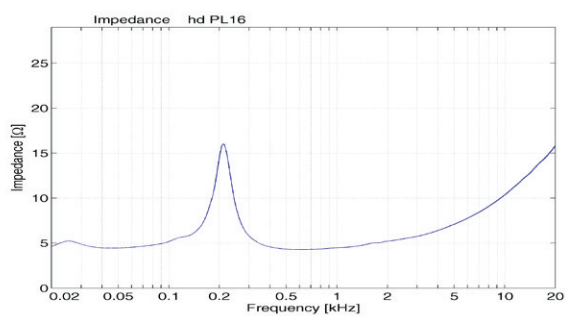

Horizontal Isobars

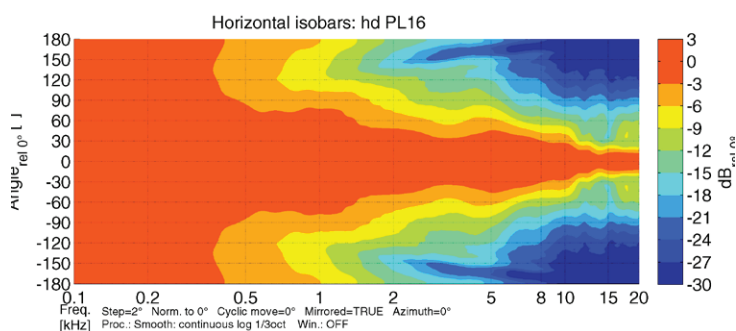

Frequency response with DSP preset

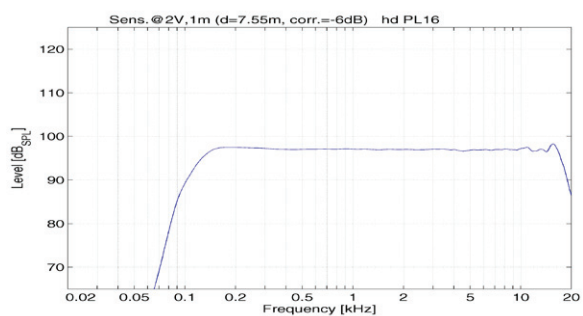

Vertical Isobars

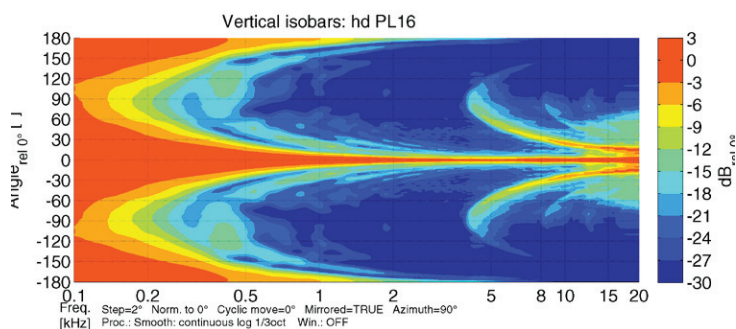

hd PL16 datasheet

Accessories

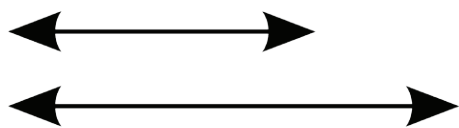

Special length

Special length of the speaker according to customer requirements

Order number: 40713 (up to 2000 mm total length)
40715 (up to 3000 mm total length)



RAL color

Special color per article according to RAL color chart

Order number: 1070



Weather resistant

Impregnation against weather influences

Order number: 4610

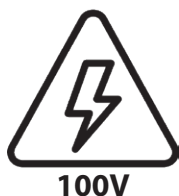

100V-Transformer

integrated 100V transformer with three power taps (30/15/7,5 W)

Order number: 1074



Mounting adapter for mobile applications

Use with tripod adapter 19780 for easy and quick installation with two thumbscrews in mobile applications

Order number: 900858 (black RAL 9005)



Double case PL16

Lightweight polypropylene double case for 2x hd PL12, with wheels, transport handle in the middle

Order number: 950046



Transport bag PL16

Durable polyester transport bag with 10 mm padding and zipper, transport handle, shoulder strap and hd logo print

Order number: 30108

hd PL16 datasheet

Accessories



Tripod adapter 19780

Tripod adapter for tilting up to 30° on a 35 mm tripod

Load capacity: 15 kg
Dimensions (W x H x D): 59 x 87 x 131 mm
Order number: 900856 (black RAL 9005)



Wall mount 24180

Wall distance 105 mm, laterally swiveling with inclination up to 15°

Load capacity: 15 kg
Dimensions (W x H x D): 70 x 130 x 105 mm
Order number: 900854BLK (black RAL 9005)
900854W (white RAL 9010)



Wall mount 24471

Wall distance 110 mm, laterally swiveling with inclination up to 30°

Load capacity: 15 kg
Dimensions (W x H x D): 90 x 160 x 110 mm
Order number: 900851BLK (black RAL 9005)
900851W (white RAL 9010)

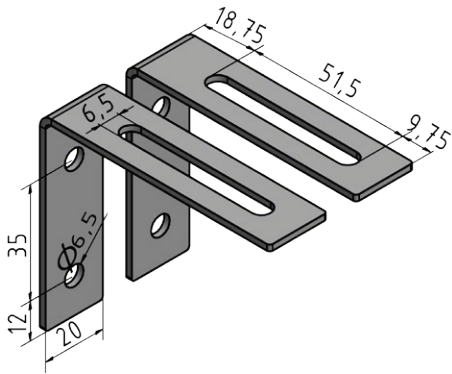

L-bracket wall mount-set

Discreet L-bracket set for extremely close mounting of the speaker to the wall. Side swivel with inclination up to 5°. The speakers housing plates are equipped with M6 inlet threads.

Incl. 2x M6x14 hexagon socket screws

Load capacity: 30 kg
Dimensions (W x H x D): 20 x 60 x 80 mm
Order number: 900106 (in RAL color of speaker)